

TIMOTHY HUBBARD PTY LTD

CONSERVATION ARCHITECT & PLANNER

4/194 ALBERT ROAD, SOUTH MELBOURNE VICTORIA 3205 AUSTRALIA
TELEPHONE (01) 696 0655

City of Coburg Heritage Conservation and Streetscape Study

BUILDING GUIDELINES

MARCH 1991

ISBN 1 875224 41 6

CLAUDE CALFIA
BE & A (Hons) MALT & ACE

TIMOTHY HUBBARD
B Arch (Hons) Arch Cons ICCROM ARATA
DIRECTOR

BRYCE RAWORTH
B Arch (Hons) B A (Hons)

CONTENTS

6.0	BUILDING CONSERVATION GUIDELINES	99
6.1	Introduction	99
6.2	Guidelines	100
6.2.1	Description of Building Types	100
6.2.2	Description of Building Styles/Periods	100
6.2.3	Research	102
6.2.4	Preservation and Reinstatement of Materials	102
6.2.6	Detailed Reinstatement for Houses	106
6.2.7	Alterations and Extensions to Existing Buildings	125
6.2.8	Fences	127
6.2.9	Colours	128
6.2.10	Summary	128
6.3	Select Conservation Bibliography	129
7.0	BUILDING INFILL GUIDELINES	131
7.1	Introduction	131
7.2	Individual Areas	131
7.3	Guidelines	131

6.0 BUILDING CONSERVATION GUIDELINES

6.1 Introduction - The philosophy and objectives behind the guidelines

These guidelines are designed for the use of private property owners, especially home owners, and municipal officials alike as an aid to the protection and enhancement of Coburg's heritage. They recognise and describe the essential nature and distinguishing characteristics of Coburg's built environment and provide appropriate alternatives for the management of that environment. In particular, they provide a guide to appropriate works for reinstatement, alteration and addition and new infill development in the belief that through them it is possible to improve the quality of the built environment in Coburg. While they concentrate on domestic architecture the principles and often the details of the Guidelines can be applied to other building types such as shops and offices.

The approach to conservation which is fundamental to these guidelines has been developed by Australia ICOMOS, the local branch of the International Council on Monuments and Sites. Its philosophies, principles and definitions, which are set out in the Burra Charter, produced by Australia ICOMOS, are the result of much debate and experience. They can be applied to any heritage site, no matter how humble, to its advantage. While every generation may leave its mark, we are custodians of our heritage for future generations.

Without careful management Coburg could continue to see a steady erosion of its surviving original building stock, comprised as it is of *buildings from all eras since European settlement in the Port Phillip area*. This erosion works against the interests of all Coburg residents. It is now accepted by most communities that the retention and maintenance of significant building stock, and a sensitive approach to design in areas in which they are found, results in an improved amenity in terms of streetscape coherence, aesthetic effect and heritage value, accompanied by communal pride and rising land values. There is a growing acceptance of the recycling of old buildings as a better alternative to demolition and new construction. With this comes an

obligation to ensure that significant buildings are treated in a fashion which is appropriate to their age, style, materials and individual significance. These guidelines are designed to promote and facilitate this process for owners and planners alike.

6.2 Guidelines

The guidelines are at two levels. The proposed Amendment to the Planning Scheme includes broad guidelines. If applicants comply with these broad guidelines to the satisfaction of the Responsible Authority a permit will either not be required or will be issued by delegation. The implementation of the broadly based guidelines should be through the detailed guidelines provided in this Study, adopted as policy by Council.

The guidelines take the form of a description of the nature of the various styles associated with the main periods of Coburg's development. This is followed by advice on how to conserve significant or old buildings and how best to make appropriate additions. The authors are indebted to David Harvey, who gave permission for the use and modification of his booklet on the conservation of period buildings.

6.2.1 Description of building types

Building type is generally defined according to function, that is Residential, Commercial, Industrial, Educational, Institutional, Civic, and Religious. These are the major building types found in Coburg, and it is their relative percentage and distribution which defines the character of life in the municipality today. The age, appearance and significance of the individual examples of these types, and their net effect, defines the heritage character and value of the municipality.

6.2.2 Description of building styles/periods

It is vital to the process of conservation that one be able to identify the period and style of individual buildings, as these provide a basis upon which to determine how to manage the *preservation*, *restoration* or *renovation* of each building (see Section 9.2 for a concise definition and differentiation of each of these italicised words). Generally speaking, the

one hundred and fifty odd years since first European settlement at Port Philip can be divided into a number of periods which are each typified by a number of quite specific building styles.

These periods are often difficult to specify precisely, because early or late examples of the representative architectural styles often appear outside the period with which they are aligned. Furthermore, one period may see a continuation or elaboration of a style which appeared in the previous period - in such cases a degree of expertise may be required in order to correctly determine the true date of the building in question. All of this means that the periods tend to overlap to some degree, however they remain a useful tool for gaining an approximate date for a building on the basis of site inspection alone. Approximate dates for these periods in Coburg are:

- Colonial (1835-c1850)
- Early to Mid-Victorian (c1851-c1875)
- Mid- to Late Victorian (c1875-c1900)
- Federation (c1901-c1918)
- Interwar(1919-45)
- Post-WWII (1946-59)

The main styles associated with these periods in Coburg are:

- Colonial:** Colonial (ie verandahed homestead)
- Early to Mid-Victorian:** Georgian, Italianate, Gothic and Free Classical
- Mid to Late Victorian:** Gothic, Carpenter Gothic, Italianate and Free Classical
- Federation:** Anglo Dutch, Arts and Crafts, Bungalow, Romanesque, Queen Anne, Gothic and Federation.
- Interwar:** Art Deco, Beaux Arts, California Bungalow, Georgian Revival, International, Moderne, Spanish Mission, Stripped Classical and Tudor Revival
- Post-World War II:** Ecclesiastical, International, Post-war Bungalow and Suburban Vernacular

While it is not possible within this study to give a detailed description of these styles and their evolution, an attempt has been made to illustrate an example from Coburg of each style from each period in the following section of the study, which describes the main materials employed in characteristic houses of each period and suggests appropriate measures for their conservation and reinstatement. Further information regarding styles of building can be sought through publications such as Richard Apperly, Robert Irving & Peter Reynolds *A Pictorial Guide to Identifying Australian Architecture* and other references listed in the Bibliography, Section 9.8 of this Study.

6.2.3 Research

Much research has already been done for A, B and C buildings in the Study. The data sheets provide a good springboard for further research. The Coburg Historical Society, which holds excellent records, and the Heritage Adviser appointed by the Coburg City Council could assist by starting and directing further research.

Much can be learned about a building, both its architecture and history, from documentary sources. Simple research can reveal an exact date of construction, a sequence of owners and occupiers, perhaps an architect and builder and the the major alterations which have occurred. Title details, municipal records and MMBW records all provide intricate and exact information. Biographical information may be gleaned from these sources and then amplified by further research using Post Office and Sands & MacDougall *Directories*, Probate papers, birth, death and marriage certificates. This research may lead to the descendants of previous owners and occupants who may hold early photographs and even original drawings.

The Coburg Historical Society has an excellent archive. Certain buildings may have their own archives, particularly religious and institutional buildings. Other buildings may belong to a type or group, such as the State Bank Housing Scheme or the War Service Homes, for which limited designs and specifications were used, and on which much sophisticated research has been undertaken. The HCV's records provide a mine of information about the Newlands Estate.

Research should be systematic, starting with known facts. Information should be recorded carefully. Original records should be copied - the originals might be lodged with a library or archive for safe keeping.

6.2.4 Preservation and reinstatement of materials

Once a building's period and style have been determined, a step which becomes more important the more drastically and detrimentally a building has been altered, it is possible to start to decide the nature and extent of appropriate reinstatement or alteration. If these alterations are perceived to be insignificant and detrimental, they may be removed or altered to be more appropriate, and the original materials and finishes of the building restored according to the guidelines laid out below. Wherever possible the advice of the Heritage Adviser or that of an architect, particularly someone specialised in conservation, should be sought to complement and perhaps explain these guidelines - this becomes more important the more significant the building, and should be seen as absolutely essential for A, B and C grade buildings.

It should be born in mind that returning to an original or homogeneous appearance is not always the most desirable approach. Sometimes an old building has been altered so as to assume a significance quite removed from its original status. It may act against the interests of conservation to remove these alterations and return the building to its original appearance, which could be easily gauged from the nearby terraces.

Similarly, Victorian buildings often have features or elements from later periods such as Federation; these have assumed their own significance, and are generally perceived as complementary to the original building. It would be a mistake to remove these, because they are now part of the building's significance as an historical artifact.

6.2.5 General Reinstatement procedures

Once it has been decided that reinstatement is the desired option there are ways to help determine how the building should be treated. First, it is important to look in the immediate vicinity for examples of similar

buildings of the same type and period which can provide clues about the original appearance of the building. Coburg was developed in a number of quite specific periods (see Section 2), and building in each of these was generally confined to particular areas. It is common to find an area which is largely composed of Victorian buildings, while nearby there may be another area which is largely Federation and yet another which might comprise 1930s bungalows only. It is therefore reasonably likely that you will find a number of adjacent or nearby buildings which were either originally identical to your own or else which shared many common characteristics.

Then a careful study of the building itself may reveal original finishes or materials of which you may have been unaware. For example, many Victorian buildings were built using a variety of coloured bricks (polychrome construction), but as these became less fashionable, or their tuckpointing began to deteriorate, they were often painted over or even covered with render. A simple but careful scraping of the paint from the surface of a painted wall in a number of places may uncover this variety of colours. Similarly, in the case of a rendered surface, an examination of the eaves or corners of the building may reveal bricks that were not rendered and that show the original polychrome surface to have been original. These later finishes can be removed using techniques outlined below if this is seen to be desirable.

Careful scraping of painted timber elements such as doors and door frames, windows and window frames may also reveal original colours, which are always the preferred option for the reinstatement of an old building. One must, however, be careful not to confuse final coats with primers and to make adequate allowance for the weathering of these surfaces (and their corresponding discolouration) when choosing an equivalent to replace them. Most major paint companies now provide heritage colour charts which indicate the colours appropriate to different eras. These can be used to find colours which approximate those originally used on the building.

Examination of the surfaces of the building may also indicate the former presence of elements which are now lost. One example of this is where the fascia of a verandah and the wall immediately below it at either

termination retain the marks or holes where cast iron ornament has been attached. Faint marks can also often be detected on wall surfaces where a verandah has been removed - these are particularly useful, as they show the extent and profile of the original verandah. Original evidence of this kind is the most valuable guide to how a building should be reconstructed.

With any building there are a few elements which determine its appearance and its role within the streetscape. These are the elements which it is most important to analyse, to compare with local examples, and then to reinstate in an appropriate fashion. Some of these elements, as one moves in from the street, are:

- Fences
- Garden landscaping (terracing, paths, etc)
- Verandahs
- Facade wall surfaces
- Windows
- Roofs
- Eaves or parapets
- Chimneys

These are the aspects of a site and building which tend to make the most immediate visual impact as one walks or drives past a building. The importance of these elements is emphasised if a building is part of a terrace or a row of similar buildings, setting up a rhythm which is broken if any of these elements have been altered or removed. Their reinstatement should take a priority.

There are also elements of buildings which are not as immediate in impact but which become more noticeable as one pauses to look at a building or approaches to enter. They generally fall into the area of details, and can be listed as:

- Path surfaces
- Garden planting (plant species)
- Verandah surfaces
- Verandah supports (detailing)
- Doors and door frames
- Windows and window frames
- Eaves or parapet ornament
- guttering and downpipes

These may be seen as secondary considerations for a building of low significance, but are absolutely vital if a building is to assume a correct, thorough and appropriate restored appearance.

6.2.6 Detailed Reinstatement Guidelines for Houses

This Section provides guidelines for the materials and finishes characteristically used for the different elements in the various periods outlined above. The guidelines are written with domestic buildings in mind but are usually applicable to commercial buildings of the same period. It is important to note that the detached house in Australia, and certainly in Melbourne, has changed little in plan over the years. Major changes occurred about 1900 and then after 1945 but most houses are still conventional. They have changed in style rather than in substance. The best introduction to the Australian house is still Robin Boyd's *Australia's Home: Its Origins, Builders and Occupiers*. Further reading is, however, recommended.

The information in this section is enough to enable the identification of a house style and to detect inconsistent alterations. Faithful reconstruction can only be done with more detailed information. The guidelines are closely based on the booklet, *A Guide to Altering Old Houses*, by David Harvey and Celia Waters, architects. Their kind permission to reproduce and add to both their text and sketches is much appreciated. Copies of the booklet are available from the municipal offices. Some other sources of information are:

- (i) Research as discussed in Section 6.2.3.
- (ii) Observation of similar houses in the same area.
- (iii) The National Trust's files and various Technical Bulletins.
- (iv) The Conservation Bibliography at the end of this text.

Colonial (1835-c1850)

So few Colonial buildings survive in Coburg that detailed guidelines are unnecessary. Each of the buildings from this time in Coburg is an A Grade Building and each deserves a formal Conservation Analysis to be prepared for it. The analysis would lead to a Conservation Plan for the long term management of the site.

Early to Mid-Victorian (c1851-c1875)

Houses

The early Victorian house took its detailing and proportions from the classical public buildings of the early 19th century. The style is formal, sober and classical. Plans are usually symmetrical about the front door though they may follow the asymmetrical Neo-Gothic. Rooms open off a central corridor which is divided by arches separating the more public from the more private areas. Kitchens and other service areas may be detached. Early examples are simple. Ornament is limited to windows and eaves. Later ornament becomes complex.

Mid-Victorian houses are formal, their facades composed of simple rectangles with restrained, applied ornament. Terrace types are generally symmetrical, sited close to the street, their facade surface dominant. Detached houses are generally asymmetrical, set further back from the street, but again the facade surface dominates. Plan forms are still simple. Rectangular rooms open off a straight corridor.

Materials & colours

Roofs: slate/corrugated iron over verandahs.

Walls: grey stuccoed brick or stone, usually unpainted but maybe limewashed; fair faced brick, always unpainted; weatherboards, always painted or limewashed.

Floors: timber or terracotta tiles to verandahs.

Principal colours: grey stucco, white window frames with black sashes. Important doors are dark stained, others are painted chocolate. Dark green venetian blinds. White painted cast iron lace lace. Unimportant woodwork chocolate.

Interiors.

Ceilings: flat plaster ceilings, wide moulded plaster cornice, central ceiling rose, ornate arches in hallways, all mouldings simple in profile.

Walls: flat plaster, painted or papered; some timber panelling in inferior rooms; moulded architraves and high skirtings, all simple and standard in profile

Floors: wide softwood (pine) boards, carpet squares and runners, oil cloth.

Principal colours: pale ivories, pastels, greys. Walls and ceiling contrasting. Finely printed satin wallpapers. Colours became deeper towards the end of the period.

Elements.

- a projecting front room semi-octagonal shape.
- b verandah (concave or straight profile).
- c shallow, hipped roof.
- d chimneys and sometimes a square tower penetrates the roof.
- e deep eaves corbelling.
- f stringcourse.
- g projecting plinth.

- h large windows, double-hung, sometimes with a curved head.
- f half-round and, later, ogee guttering with circular downpipe (rarely cast iron) supported on scotia mould.

Proportions.

Composition: classical, frontal; balanced and restrained; high ratio of solid to void.

Elements: square to rectangular.

- a projecting wing square to slightly vertical rectangle.
- b main building facade is usually a horizontal rectangle.
- c whole facade is divided into horizontal bands by the eaves line, string course and plinth.
- d windows are vertical rectangles often divided into triple lights.

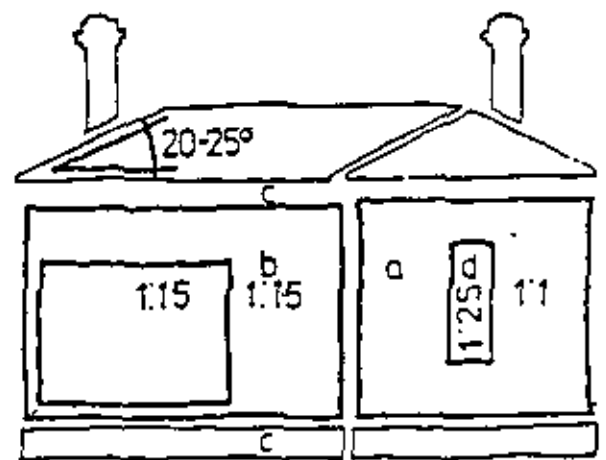

Ornament.

- a cornice moulding and brackets to eaves
- b cornice to chimneys
- c mouldings to window head and surrounds.
- d heavy four panelled door, sometimes glazed.
- e coloured glass sidelights and fanlight to front door.
- f simple timber bressumer and brackets or cast iron lacework to verandahs.

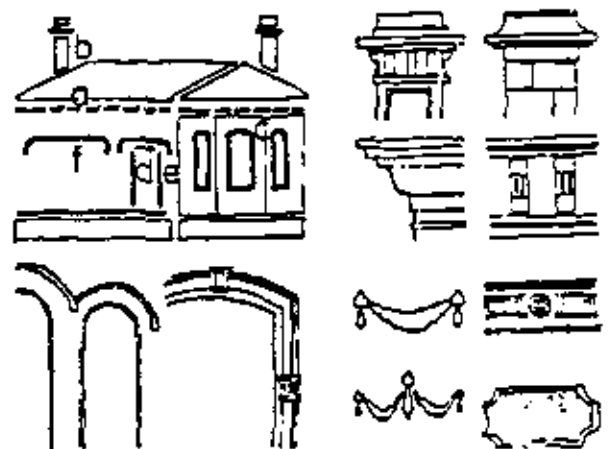

Fences & Gardens

Character: Formal, clipped, neat small lawns. Large flower beds.

Vegetation: Buffalo grass lawns. Beds of flowers and low shrubs. European not Australian trees. Plants used for their exotic qualities and used in contrast with each other.

Paths: straight gravel paths make direct entry.

Fences: simply patterned single or double cast iron palisades fixed to bluestone plinths. Timber pickets/palings or even rails.

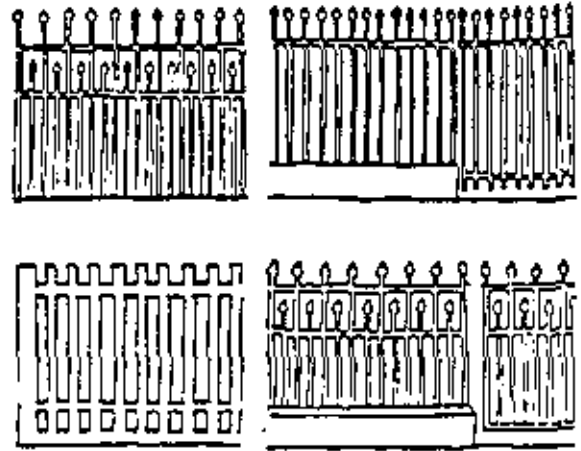

Late Victorian (c1875-c1900)

Houses

The late Victorian period coincided with a period of great increase of wealth in Australia. Detached house plans were derived from the asymmetrical Gothic type. A straight corridor led through the house with rooms strung asymmetrically along it. Terraced houses were planned symmetrically, with each house mirrored by its neighbor around the lightwell. Detailing was based on the Early Victorian style but was much embellished and more extravagant. It is the style's most dominant feature. There was a rise in the fashion for polychrome brickwork.

Materials & colours.

Roof: slate/corrugated iron bullnosed over verandah.

Walls: brick - early examples were rendered imitation stone, later examples were of white tuck pointed polychrome brickwork. Weatherboard, sometimes as imitation stone/ashlar.

Floors: mosaic/terracotta tiles to verandah or timber boards.

Principal colours: early examples grey stucco, later examples red yellow brown bricks. Woodwork was painted white, stone, brown or given a dark stain ("graining" was popular). Dark green or red venetian blinds.

Interiors.

Ceilings: moulded plaster, pressed metal or timber panelled ceilings with wide deeply moulded cornice. Elaborate central ceiling rose. Ornate arches in hallways. Ceiling papers common.

Walls: plaster or timber panelled with deep moulded architraves and high skirtings. Picture rails. Usually papered with several elaborate designs.

Floors: narrow timbers, parquetry; in grand houses, carpet squares and runners, oil cloth.

Principal colours: early examples - soft greyed ivories, pastels. Later examples - deeper colours often with red/blue, orange-green frieze. Floral wallpapers to picture rails, frieze papers and textured papers common.

Elements

- a arcaded verandahs.
- b projecting decorated party walls.
- c deep cornice moulding.
- d high plinth.
- e heavily decorated parapet above verandah hides low pitched roof.
- f large double hung windows often with arched heads.
- g ogee guttering supported by scotia or bolection mould and circular downpipes.

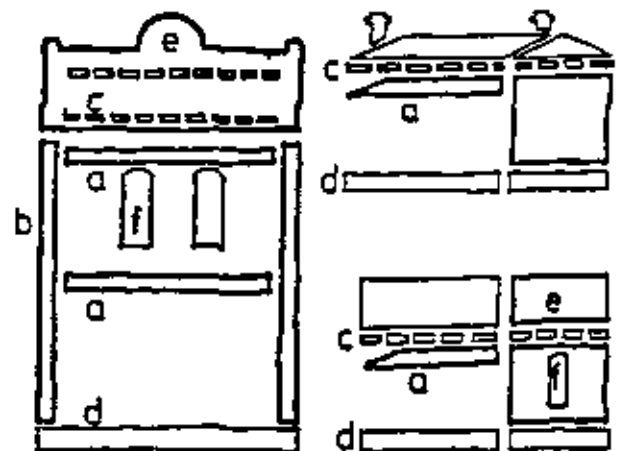

Proportions.

Composition: classical, frontal; high ratio of solid to void.

Elements: rectangular.

- a strong rectangles are formed by the projecting party walls and horizontal verandah lines (terrace type).
- b verandah posts and cast iron lace subdivide the facade into smaller rectangles.
- c whole facade is divided into horizontal bands by cornice, verandah lines and plinth.
- d one storey house has scale of two storey.
- e windows are vertical rectangles, sometimes exaggerated.

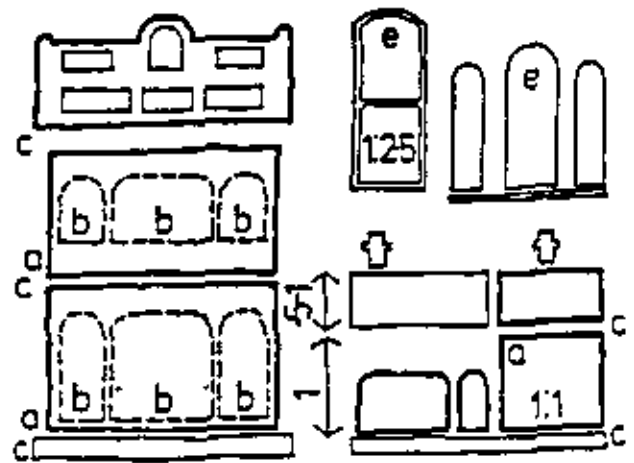

Ornament.

- a cast iron lace to verandahs and balustrades (late examples imitate timber fretwork and turned timber).
- b parapet above verandah is stuccoed and decorated with a profusion of label moulds, pilasters, brackets, scrolls, floral motifs, urns, balls often topped by a pediment.
- c deep bold cornice moulding and friezes.
- d cornice to chimney.
- e window head moulding, spiral mullions.

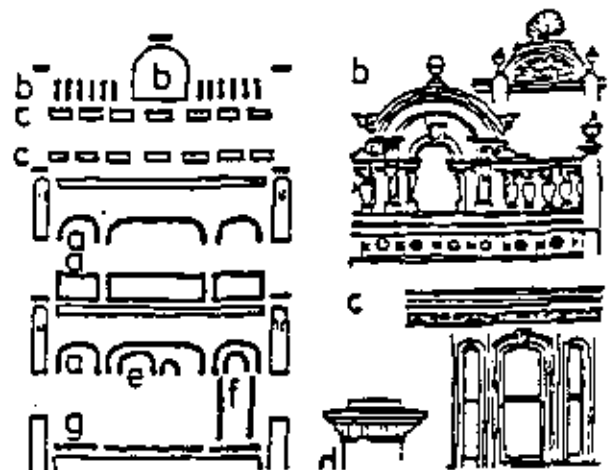

f heavy panelled doors with richly glazed sidelights.

Fences and Gardens

Character: clipped and neat. Large lawns and small flowerbeds.

Vegetation: buffalo grass lawns, beds of flowers. Low shrubs. European not Australian trees. Plants chosen for their exotic qualities and used in contrast with each other.



Paths: Straight direct path in patterned mosaic or terracotta tiled.

Fences: Elaborately patterned cast iron balusters fixed to bluestone plinth; timber pickets and corrugated iron on timber framing

Federation (c1901-c1918)

Houses

The Federation house is the antithesis of the Late Victorian house. Its designer's objective was to be quaint and picturesque. It is asymmetrical and is characterised by a complicated, steeply angled roof form. It is essentially a red brick, cream painted render style. There are however cream weatherboard and red corrugated iron versions. It was derived from the English Queen Anne movement.

Materials & colours.

Roofs: orange, terracotta Marseille tiles; corrugated iron.

Walls: smooth red bricks, black and green tuck pointed joints; roughcast render and half timbering to gable ends; roughcast on timber laths; square edged weatherboards sometimes notched to simulate shingles.

Principal colours: red bricks, cream render, buff cream dark brown/dark green timber windows and other woodwork.

Interiors.

Ceilings: fibrous plaster sheet ceilings, joints covered with 50mm wide plaster on timber straps. Moulded cornice with painted frieze below. Fretwork trellis to arches.

Walls: flat plaster. Timber panelling, often to high level. Picturesque carved fireplaces. Built-in shelves. Paint more popular than wallpaper.

Principal colours: dark stained timber panelling, cream deep warm beige, some red and green to front rooms. Japanese influence.

Floors: timber boards, carpet squares and runners, rarely fitted carpets, linoleum.

Elements.

- a one or two wings project (at right angles to one another) from the front of the house and to the side. New emphasis on the diagonal.
- b low shadowed verandah curves around between wings.
- c high pitched, dominating and complicated roof often with turrets and false dormers to give a vertical interest.
- d tall ornate brick chimneys penetrate roof.
- e picturesque leadlight casement windows.

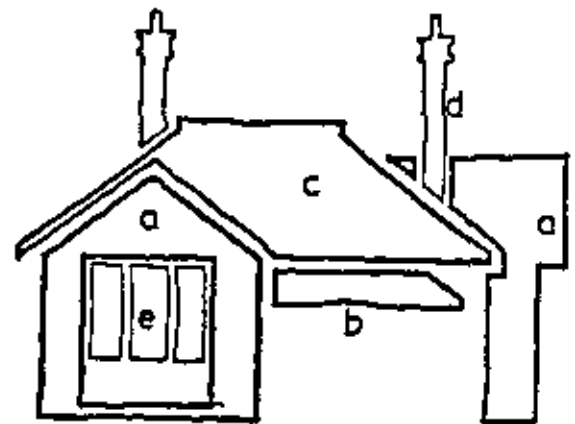

f ogee guttering supported on bolection mouldings, and circular downpipes.

Proportions.

Composition: informal, vigorous, with new emphasis on verticality.

Elements: fragmented triangles over low horizontal rectangles.

- a profusion of steeply angled roof planes gives verticality.
- b lie of eaves, verandah shadows give horizontality.
- c windows are vertical rectangles usually grouped or bayed.
- d wings pull horizontally and chimneys vertically from the centre.

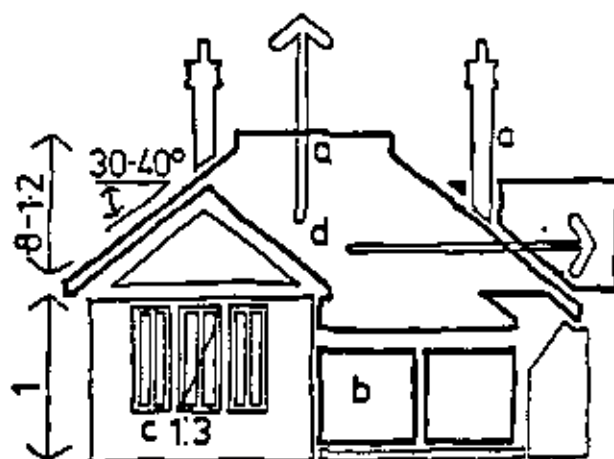

Ornament.

- a timber fretwork to verandahs and eaves, rarely cast iron.
- b terracotta roof ridge capping in fanciful shapes. Gable ends and dormers are topped with a terracotta finial often dragons, griffins, kangeroos or emus.
- c chimneys built in fluted shapes with cornice and terracotta pots.
- d leadlight casement windows.

Note: new interest in Australiana as a decorative source and introduction of stylised Art Nouveau.

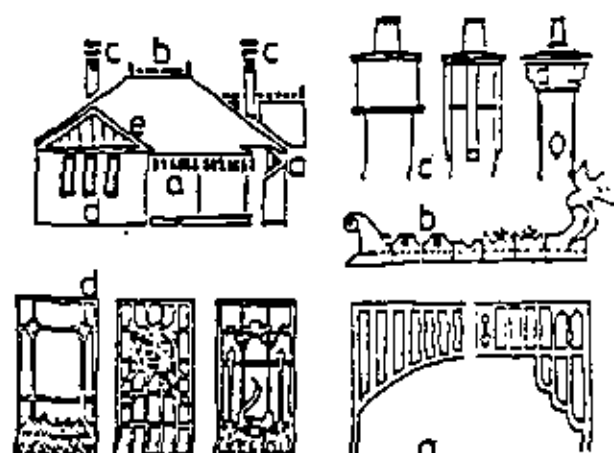

Fences and Gardens

Character: formal neat large lawns.
Narrow flower beds.

Vegetation: buffalo grass lawns. Beds of flowers and low shrubs. European not Australian trees. Still with an emphasis on different qualities but more dark, rich foilage. Palms become popular.

Paths: patterned mosaic or terracotta tiled straight direct path.



Fences: elaborately patterned cast iron balusters fixed to bluestone plinth. Timber pickets or corrugated iron on timber framing. Red brick masonry.

Interwar (1919-45)

Houses

Interwar development (typified by the Californian Bungalow) was imported from America. Its designers aimed at giving a rugged yet cosy and warm image. It has the feeling of a fortress, excluding nature, but it is built of textured natural materials. The plan form is a compact rectangle with usually two or three bedrooms. More extravagant two storey versions were built for the rich. Forms are simple, surfaces are broad and unbroken.

Other styles gained in popularity in this period also. Spanish Mission, Tudor Revival and Georgian Revival as well as streamlined Moderne and International Modern were used as stylistic overlays to what was

generally the basic builders' bungalow - conventional in plan, double or triple fronted and single storey.

Materials & colours.

Roofs: red, orange and green cement tiles. Terra cotta tiles continue to be used

Walls: brick, weatherboard, roughcast render or pebble finish to elements such as brick pillars, balustrade, timber shingles and roughcast render. Pebble finish to gable ends. Clinker brick chimney. Rarely roughcast on chicken wire. Square edged weatherboards.

Principal colours: red bricks, clinker bricks, oil stained dark brown weatherboards. Brown, ivory, green and sometimes even bright red woodwork.

Interiors

Ceilings: fibrous plaster sheets with stained timber cover straps to joints. Small cornice Adam Revival, Art Deco and Spanish Mission styles also popular.

Walls: plaster/dark stained plywood panelling to 1.8m high, picture rail at 1.8m.

Note: often art nouveau patterns to glass panels in doors and windows.

Principal colours: dark stained timber or natural timber panelling. White walls and ceilings.

Elements

- a very large gable ends
- b broad roof planes, main roof pitch not less than 25 degrees. Porch roof not less than 15 degrees.
- c deep front verandah.
- d massive chimney on external wall.
- e small pokey windows punched in the wall - casement or double

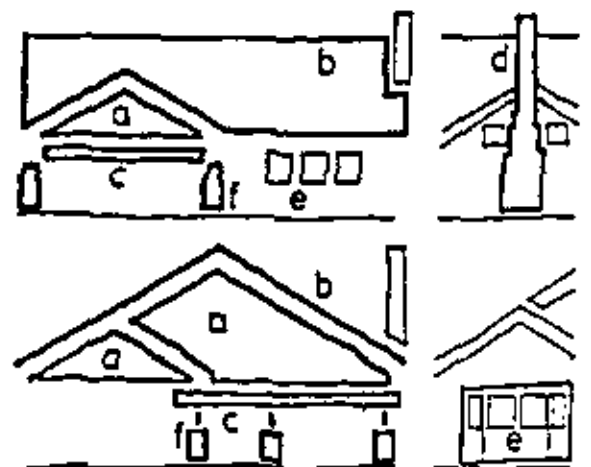

- hung type - often a bay window to front room.
- f massive pylons to front verandah.
- g quad guttering supported on quad moulding and circular or square downpipes.

Proportions.

Composition: informal, frontal rectangular plan form with one room thrust forward.

Elements: triangular roof form over horizontal rectangles. Elements are thick and massive.

- a large low roof. Prominant gable ends.
- b horizontal verandah lines.
- c windows are square to horizontal rectangles divided into vertical rectangles by mullions.
- d elements are bold and simple.

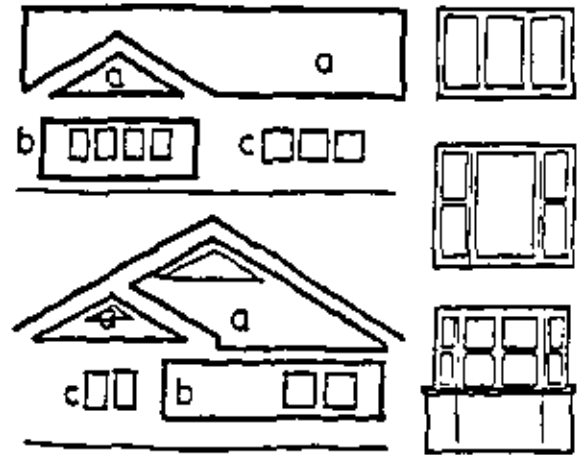

Ornament.

- a timber shingles, roughcast render and pebble finish to gable ends.
- b brick walls partly roughcast render or pebble finish.
- c brick or stone capping to balustrade wall.
- d projecting rafters. Curved bressumer to verandah.
- e tapered pylons sometimes topped with timber posts.
- f window, door glass, sidelights usually patterned with Art Nouveau or Art Deco motifs in leadlight. Introduction of steel framed windows.

Note: Adam Revival, Art Deco, Tudor Revival and Spanish Mission styles became popular.

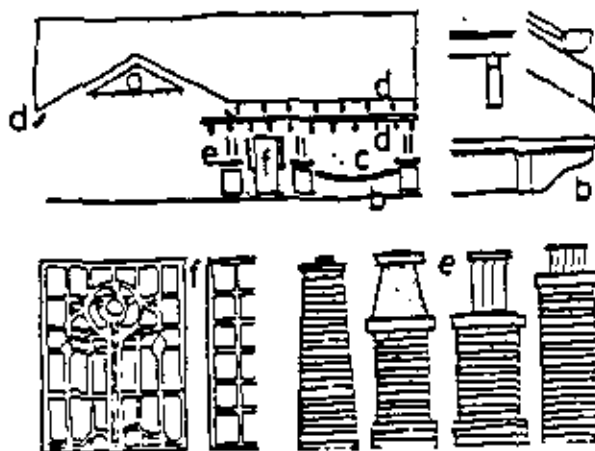

Fences and Gardens

Character: tangled, twisted and picturesque lines.

Vegetation: Buffalo grass lawns, clumps of shrubs and bushes. Australian native trees. Less interest in flowers. Standard roses.

Paths: twisted flagstone path rambled around garden.

Fences: woven wire fixed to timber framing. Trimmed hedge behind low brick wall - finished as in house.



The interwar period is of particular significance as that in which Coburg not only was declared a city, but also began to fill out and look like a city. A high proportion of the buildings and areas noted in this study date from the interwar period. For this reason an Appendix providing more detailed information on the houses of the period has been included, Section 9.6.

Postwar (1946-59)

Houses

In the thirties the simple detached cottage became the most popular house type. This had a simple L-shape with a gable or hip roof. It passed through several phases - 'Streamlined Moderne', 'Art Deco', a postwar Austere style and finally evolved into the 'elongated "L" shape' of the 50's. The early modern home design was based on 'functionalism' as an architectural theory, its features being streamlined horizontality, a lack of decoration and machine inspired styling. In Coburg the period is typified by the archetypal Australian double fronted brick veneer and various types of prefabricated steel and timber bungalows, some of the latter having been imported from Europe.

Materials & colours.

Roof: cement tiles, terracotta tiles, concrete slab over porches.

Walls: face bricks usually with half round tooled joints - red, cream and clinker bricks popular for certain styles.

Floors: hand ground terrazzo floor to porch. Timber internally.

Principal colours: salmon, brown, dark manganese, striped tapestry bricks, rounded edged weatherboard, cream woodwork, cream or green steel windows.

Interiors.

Ceilings: flush plaster with heavy stepped plaster cornice or 50mm scotia mould cornice. Flat central ceiling motifs.

Walls: hard plaster. Plain skirting. Picture rails.

note chromium plated door furniture, taps. Sandblasted plate glass doors and mirrors. Streamlined built-in furniture.

Principal colours: cream, green, apricot and other autumnal tints. Some cherry red, blue.

Floors: hardwood boards polished with carpet squares and runners, fitted or wall to wall carpets more common, linoleum, vinyl.

Elements.

- a projecting front room.
- b minimum pitch tile roof. Often hip roof.
- c boxed eaves gutter finished against corbelled brick gable or returned around gable for 450mm.
- d flat slab roof to small porch supported on 75mm diameter steel column.
- e large windows, often corner type or small portholes.
- f single external chimney projects through eaves, quad gutters supported on quad mouldings, with circular or square downpipes.

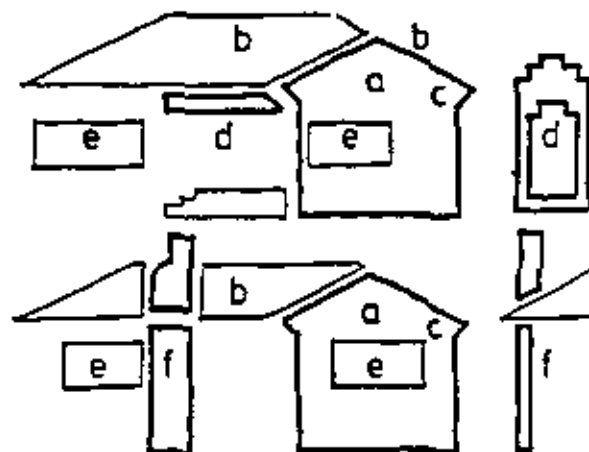

Proportions.

Composition: informal. Only complexity around entry and chimney. Corner entry.

Elements: horizontal rectangles, low triangles.

- a low pitched triangular roof.
- b walls are horizontal rectangles.

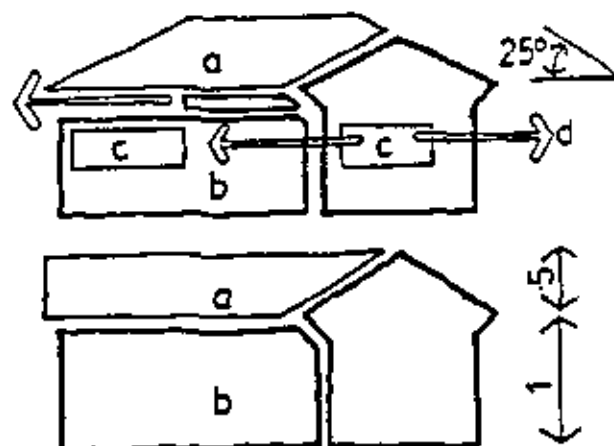

- c windows are horizontal rectangles divided horizontally with three or four horizontal bars.
- d the whole facade aims at a streamlined horizontality.

Ornament.

- a boldly modelled verandah
- b entry doors, front gates decorated with sunrise, quarter circle and other geometric motifs, house numbers emphasised.
- c horizontal lines picked out in cream or green paint or with contrasting brickwork.
- d horizontal transom bars divide windows
- e portholes, often in 'threes'.
- f modelled chimneys.

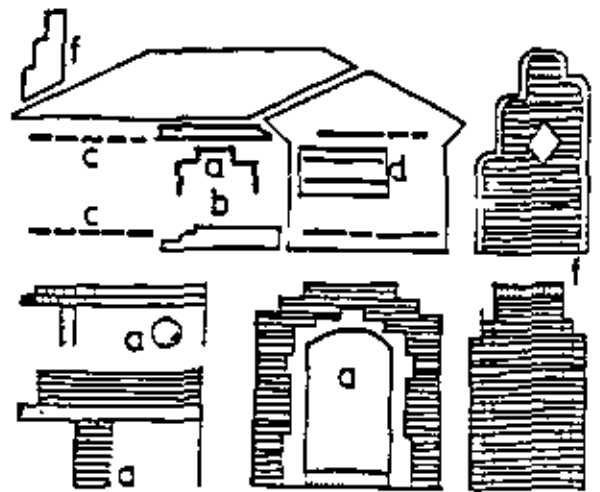

Note: sailing ship, skyscraper and sunset images were popular as last vestige of Art Deco/Streamlined Moderne.

Fences and Gardens

Character: showy, neat and trimmed/straight lines.

Vegetation: lawns, border plants and decorative trees. Back garden has vegetable plot and fruit trees.

Paths: straight concrete or gravel paths. Crazy paving.

Fences: low brick fences using bricks and detailing similar to the house. Low cyclone wire and timber plank fences. Having no fence also became popular.

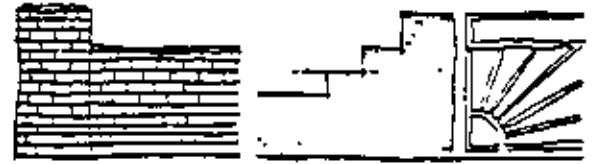

Newlands

The Newlands Area can be considered separately because of its homogeneity and the fact that only a limited number of solutions were employed for materials, fence types and so forth. The one and two storey buildings are aligned with those described in the previous, Postwar section - they are generally horizontal in articulation and are free of external decoration.

Materials & colours

Roof: cement or concrete tiles, corrugated fibro cement.

Walls: face bricks with half round or struck joints.

Floors: Concrete porch. Timber internally.

Principal Colours: Clinker, salmon or cream bricks, cream woodwork and cream steel windows.

Interiors.

Ceilings: flush plaster with heavy stepped plaster cornice or 50mm scotia mould cornice. Flat central ceiling motifs.

Walls: hard plaster. Plain skirting. Picture rails.

Principal colours: cream, green, apricot and other autumn tints.

Floors: hardwood boards polished with carpet squares and runners, fitted or wall to wall carpets more common, linoleum, vinyl.

Elements.

- a projecting front room.
- b minimum pitch tile roof. Often hip roof
- c boxed eaves gutter finished against corbelled brick gable or returned around gable for 450mm.
- d flat slab roof to small porch supported on 75mm diameter steel column or timber frame.
- e large windows, often corner type or small portholes.
- f single external chimney projects through eaves, quad gutters supported on quad mouldings, with circular or square downpipes.

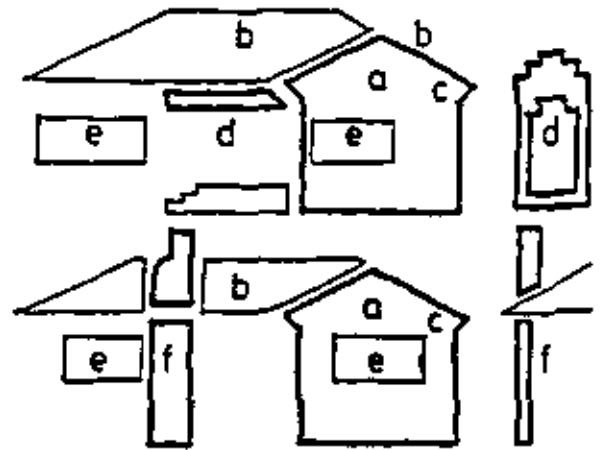

Proportions.

Composition: informal. Only complexity around entry and chimney. Corner entry.

Elements: horizontal rectangles, low triangles.

- a low pitched triangular roof.
- b walls are horizontal rectangles.
- c windows are horizontal rectangles divided horizontally with three or four horizontal bars.
- d the whole facade aims at a streamlined horizontality.

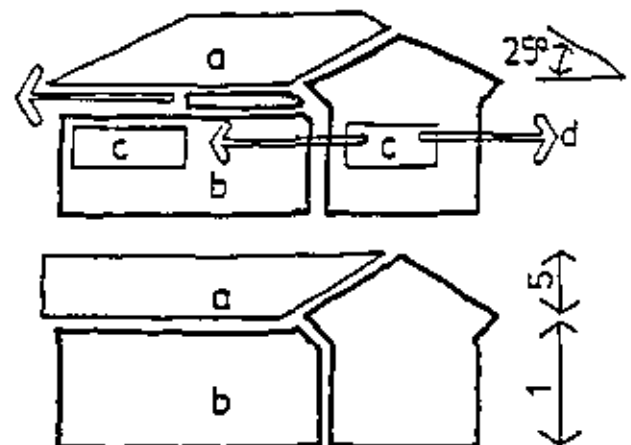

Ornament.

All ornament kept to a minimum as a cost saving device.

Fences and Gardens

Character: neat, with trimmed straight lines.

Vegetation: lawns, border plants and decorative trees. Back garden often has vegetable plot

Paths: concrete

Fences: fences are generally of the cyclone wire, short vertical paling or horizontal paling types. Brick fences were generally considered too expensive by the Housing Commission, and not all houses have fences. All fences are low, generally less than 1m, and new fences should maintain the height of adjacent original fences. Fences are often accompanied by border beds of shrubs and flowers.

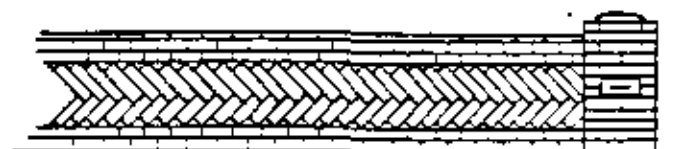

6.2.7 Alterations and Extensions to Existing Buildings

Changes to an old building should be made in the spirit and character of the original design. It is generally recommended that the forms, materials and fenestration of the new building emulate the original and that the detailing emulate but not copy that of the original. The details should be simplified versions of, and

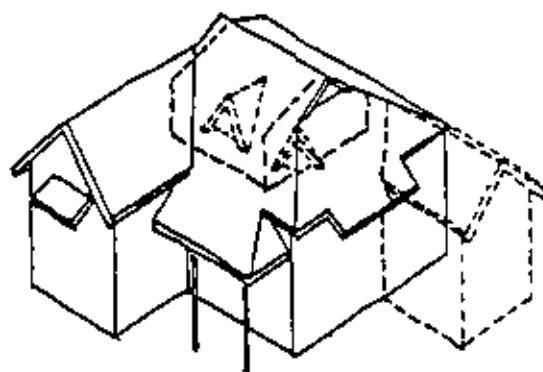

complimentary to, the originals but not necessarily identical. If the reproduction of details is exact, a most difficult thing to achieve, then this can be misleading and lead to confusion. If the reproduction is an approximation then the effect is merely pseudo-historicism, which soon dates. This is particularly important for additions such as kitchens and bathrooms where they are likely to be filled with new appliances which would look incongruous in pseudo-historic interiors.

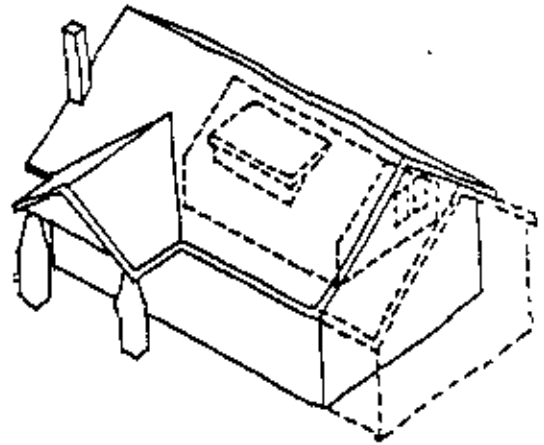

Nineteenth century buildings are generally composed of elements such as bay windows, verandahs, columns, projecting party walls and ornament to provide interest whereas twentieth century design incorporates little applied ornament but places greater emphasis on flat surfaces to form the composition. The most important considerations when designing alterations are:

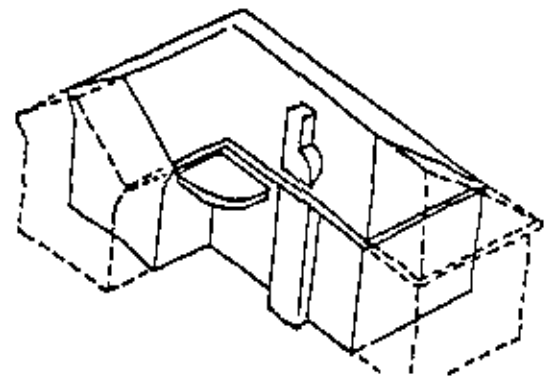

- (i) **Forms:** roof shape, verandah or porch type, use of parapets, use of curved rather than square corners - these should be similar to and of the same scale as the original.
- (ii) **Proportions:** the wall to roof ratio, roof slopes, solid to void ratio and window shapes should be identical.
- (iii) **Materials:** textures and colours of materials should match existing.

The general complexity should also be consistent with the original building.

When undertaking additions to an A, B C or D building, in which case a permit must be sought, changes should be made only in the 'view shadow' of the street elevation. The view shadow is that area of the building sheltered from sight of the street either by its own fabric or that of its neighbours(see diagram). This maintains the original appearance of the building from the street and thus its contribution to the streetscape.

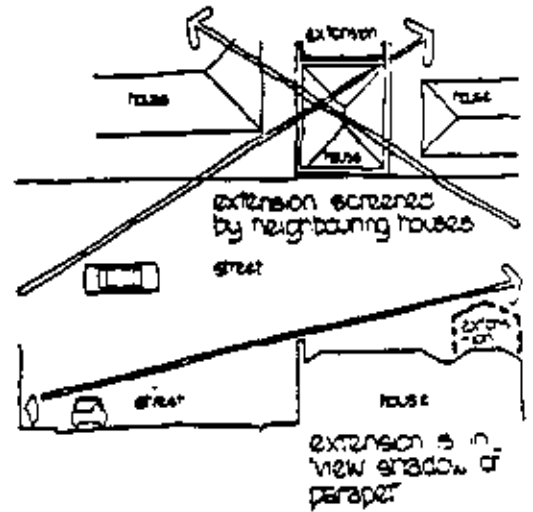

When making alterations to an unlisted building in a Conservation or Urban Design Area it is important that the altered building reflect the character of the street. Additions to unlisted buildings in Conservation or Urban Design Areas should therefore conform to the guidelines given in Section 7.3, for infill development. This protects the rhythm of the streetscape by ensuring that the altered building respects the character and scale established by adjacent buildings and the streetscape as a whole

6.2.8 Fences

It is important when designing fences to consider which type is most appropriate for a particular style of house. The fence types consistent with each of the seven periods previously described are illustrated above together with a description of their main characteristics. Most suburban timber fences should be less than 1.2m high. Attention should also be paid to the following general observations:

- (i) high front fences can spoil the image of a house and its neighbours.
- (ii) high front fences encourage burglaries.
- (iii) high front fences do limit street noise but hedges, in association with a low fence of the appropriate type, may be just as effective and are much more sympathetic to traditional streetscapes.

6.2.9 Colours

A permit is required for painting of listed buildings or of infill in Areas only if the proposed colours do not conform to those recognised as appropriate to the period of the particular listed building or of the streetscape in which an infill is located. A general indication of colours appropriate to the various periods has been given above. Other, more specific sources of traditional colours are:

M.Lewis & A.Blake, *Exterior Paint Colours : a Guide to Exterior Paint Colours for Buildings of the Victorian Period*, Technical Bulletin 1.1; The National Trust of Australia (Vic).

Traditional/Heritage colour charts, now provided by most major paint companies.

If the proposed colours conform to those indicated as appropriate by these sources then a permit is not necessary. If they do not conform then a permit must be sought. A permit is not required for painting unlisted, existing buildings regardless of whether they are within or outside Areas.

6.2.10 Summary

Remember these useful guidelines:

- (i) Good building maintenance is good housekeeping.
- (ii) Keep as much as possible of the original building fabric.
- (iii) Don't hide the original style.
- (iv) If you have to replace old building fabric, replace it with similar new material.

6.3 *Select Conservation Bibliography*

R.Boyd, *Australia's Home*; (Pelican) Melbourne 1952.

P Cuffley *Australian Houses of the '20s and '30s*, (Five Mile Press) Melbourne 1989.

S.Forge, *Victorian Splendour*, (Oxford University Press) Melbourne 1981.

J.M.Freeland, *Architecture in Australia, a History*, (Pelican) Melbourne 1968.

W.Hatton, *Adding on for Granny, a guide to alterations and extensions*; The National Trust of Australia (NSW) 1980.

W.Hatton, *Renovating a Federation Style House*; The National Trust of Australia (NSW) 1978.

M.Lewis & A.Blake, *Exterior Paint Colours : a Guide to Exterior Paint Colours for Buildings of the Victorian Period*,.Technical Bulletin 1.1; The National Trust of Australia (Vic).

M Looker & J Patrick *Understanding and Maintaining your Historic Garden*, MPE & HBC, Melbourne 1987.

C Lucas *Conservation and Restoration of Buildings, Philosophy and Approach*, Australian Council of National Trusts, Sydney 1978.

C.Lucas, I.Evans, *Colour Schemes for Old Australian Houses*; (The Flannel I.Stapleton, Power Press) Sydney 1984.

P Murphy *The Decorated Wall: Eighty Years of Wallpaper in Australia*, Historic Houses Trust of NSW, Sydney 1981.

R. Peterson, *Fences and Gates*, Technical Bulletin 8.1, The National Trust of Australia (Vic) 1988.

I Stapleton *How to Restore the Old Aussie House*, (Fairfax) Sydney
1983.

G Tibbits *Lettering and Signs on Buildings c1850-1900*, Technical
Bulletin 2.2, The National Trust of Australia (Vic) 1984.

Period Building Restoration Trade and Suppliers Directory., (Mount
Eagle Publications) Melbourne, published annually.

7.0 BUILDING INFILL GUIDELINES

7.1 Introduction - The Philosophy and Objectives Behind the Guidelines

These guidelines are designed for the use of private property owners and municipal officials alike as an aid to the protection and enhancement of Coburg's heritage. They provide a guide to appropriate works for infill development, designed to protect significant streetscapes. Precedent in other suburbs has shown that adherence to such guidelines is likely to result in an improved amenity in terms of streetscape coherence, aesthetic effect and heritage value, accompanied by communal pride and rising land values.

7.2 Individual Areas

Many areas in Coburg have been identified in this study for their historic, architectural or natural significance. Some share similar characteristics, some are quite distinct. Other areas, not formally identified but potentially of significance, are also similar. Each area has been described with its own outline history and statement of significance. It is important that each area's characteristics are fostered. What may be appropriate in one is not necessarily appropriate in another.

Before using the guidelines, the traditional character of the particular area should be properly understood. These guidelines can also be used for those areas listed in Section 3.3.4 and for sites which are contiguous with individually identified buildings outside Conservation and Urban Design areas.

7.3 Guidelines

The primary criterion for appropriate infill developments is that they should complement the character of the streetscape and the adjacent buildings in terms of building form, articulation, materials, setback and height. It is neither intended nor desirable that new buildings should be built as exact reproductions of period houses - the optimum objective is

that infill should be recognisably new and representative to some degree of contemporary design and detailing, while deferring to the existing character of the streetscape and nearby buildings. As discussed in the addition guidelines, Section 6.2.7, these guidelines apply only to those parts of the building which fall within its view shadow - other aspects of the design are regulated by the standard Planning and Building controls which apply to developments both inside and outside Conservation Areas. Put simply, new development should show good manners towards the existing environment.

Building Form

The building form of infill developments should reflect that of adjacent buildings. Factors which should be taken into consideration include:

- roof type - hip, gable, skillion, flat
- facade - single, double or triple fronted facade
- number of storeys, and their external articulation

The infill should faithfully reflect the dominant character of the street and/or adjacent buildings in terms of each of these factors, as well as those described in detail below.

Articulation

The articulation of the building relates to such factors as fenestration (window arrangement), attic storeys, chimneys and verandahs. Infill development should relate to adjacent buildings in these terms.

Colours

A permit is required for painting of infill in Areas only if the proposed colours do not conform to those recognised as appropriate to the period of the streetscape in which the infill is located. It is recognised that a greater latitude in terms of colour is appropriate for new building, but the overall effect should not be detrimental to the streetscape. A general indication of colours appropriate to the various periods has been given above. Other, more specific sources of traditional colours are:

M.Lewis & A.Blake, *Exterior Paint Colours : a Guide to Exterior Paint Colours for Buildings of the Victorian Period*, Technical Bulletin 1.1; The National Trust of Australia (Vic).

Traditional/Heritage colour charts, now provided by most major paint companies.

If the proposed colours conform to those indicated as appropriate by these sources then a permit is not necessary. If they do not conform then a permit must be sought.

Height

Infill developments should maintain the scale of buildings in their street, and that of adjacent buildings in particular. No new building should dominate because of its height, or be incongruously small. Height is measured as much in storeys as it is by metres - buildings of either one or two storeys usually predominate in a specific streetscape, and this should provide the basis for the scale of the infill development. If the infill is between two double storey buildings then it should be two storeys. If the infill is between two single storey buildings then it should be one storey only. Furthermore, no infill may be greater in height than the higher of the buildings on the two adjacent properties with congruent street frontages. This applies even if the infill is on a corner site. An exception may be considered where a recently demolished building on the site has not conformed to these principles.

Materials

It is desirable that new buildings should utilise the materials employed by other buildings in the street. This means that if an area comprises mostly timber bungalows with a few brick buildings then the new building should be of timber or brick - aluminium cladding, walls of glass and other materials which are not represented in the existing streetscape should be used with discretion or not at all. They may, however, be used in those parts of the building outside the view shadow of the building. Materials should also be used in an appropriate fashion, ie bricks should be weather struck or flush struck but not raked.

Orientation

Infill should almost always address the street directly, with its facade more or less parallel to the line of the street. It is quite rare for buildings built before the Postwar period to be placed at an angle to the line of the street. Certainly in Coburg there are no Conservation or Urban Design Areas in which this traditional orthogonal alignment is not observed by the majority of buildings. It is therefore extremely important that infill does not break the rhythm of the street through incorrect, diagonal orientation.

Setback

Infill developments should conform to the standard setbacks observed in the street, and the setbacks of buildings on contiguous sites in particular. A good rule of thumb is that no new building should be set further forward than the limit described by a line drawn between the near front corners of the adjacent buildings. Nor should a new building sit further back on its site than that neighbor set furthest from the street.

The same principles apply to setbacks from side boundaries, though these are generally regulated by municipal building codes.

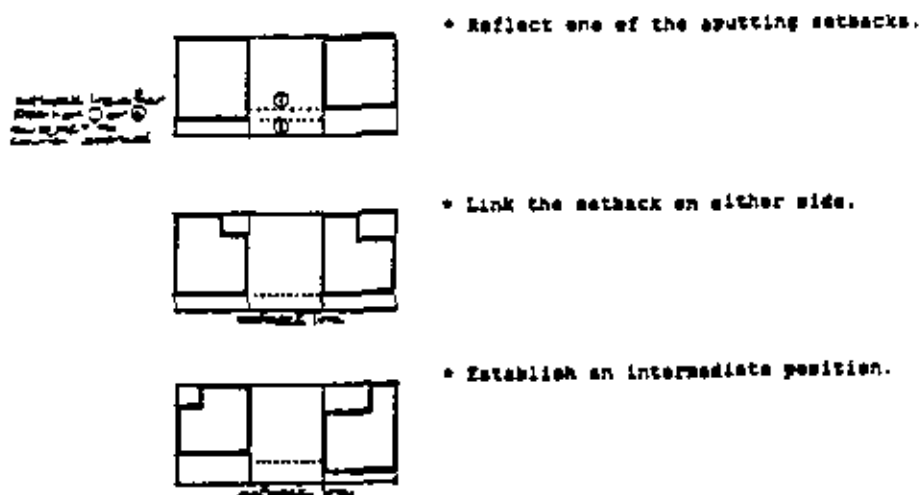

Note: additional storeys

A building having two storeys may be considered appropriate in a single storey streetscape providing that the view shadow requirements described in Section 6.2.7 for additions to houses in areas are observed, ie infill in a single storey streetscape may have two storeys in those parts of the building not visible from the street and providing that the visible parts of the building satisfy the various other criteria set by these guidelines, Section 7.3. The same principle applies in predominantly two storey streetscapes.